

6187-3 Produktübersicht MK600 Typ 5101+5115

09/13

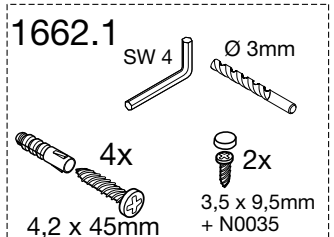

Produktübersicht Typ 0862/0863+0873

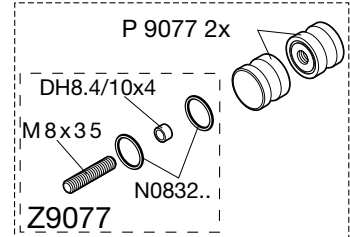
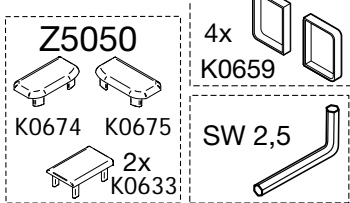
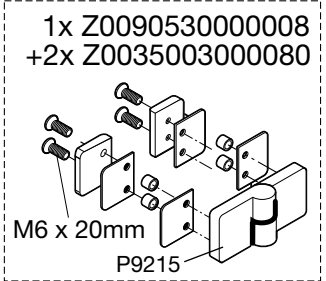
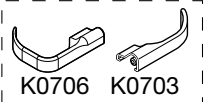
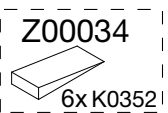
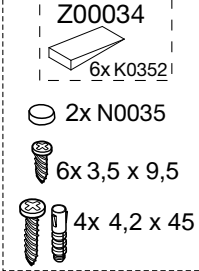
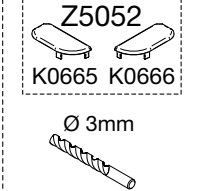
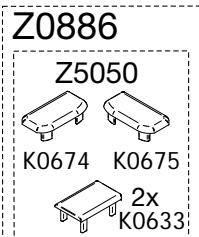
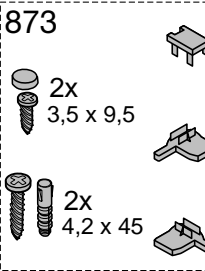
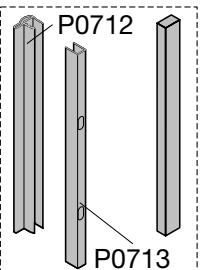
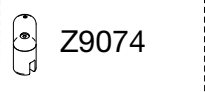
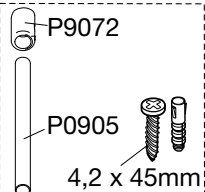
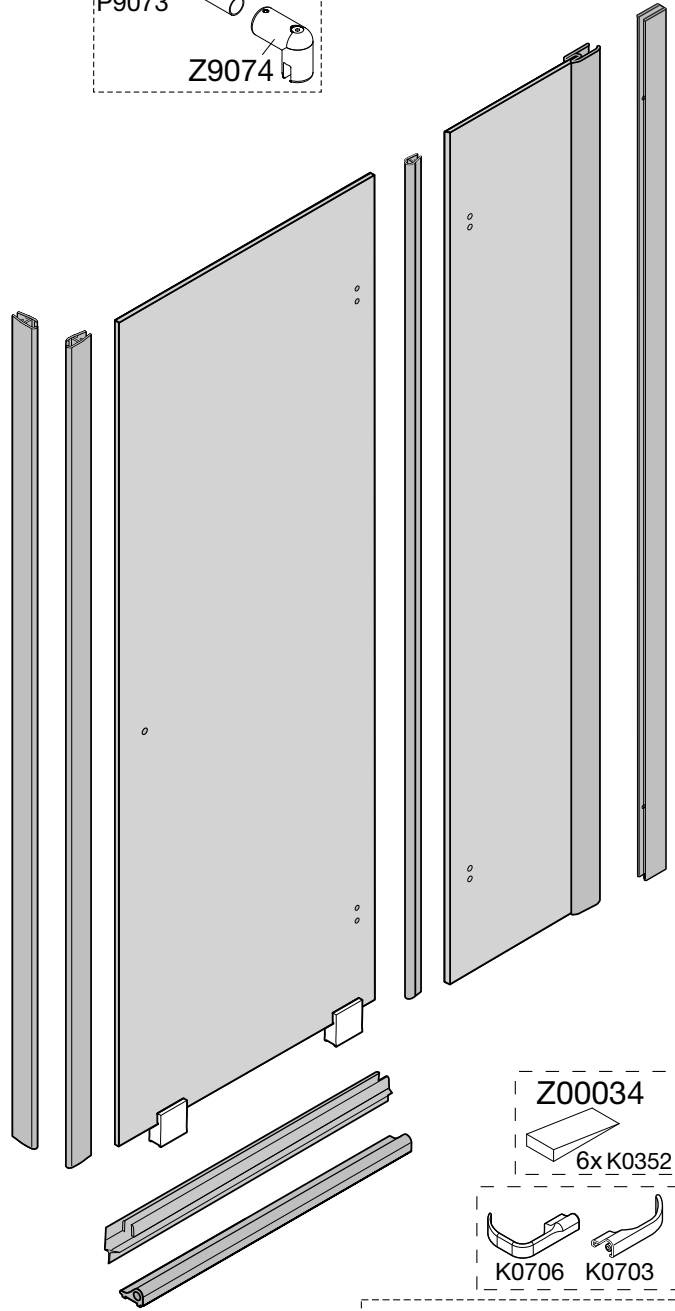
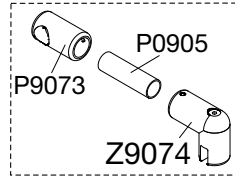
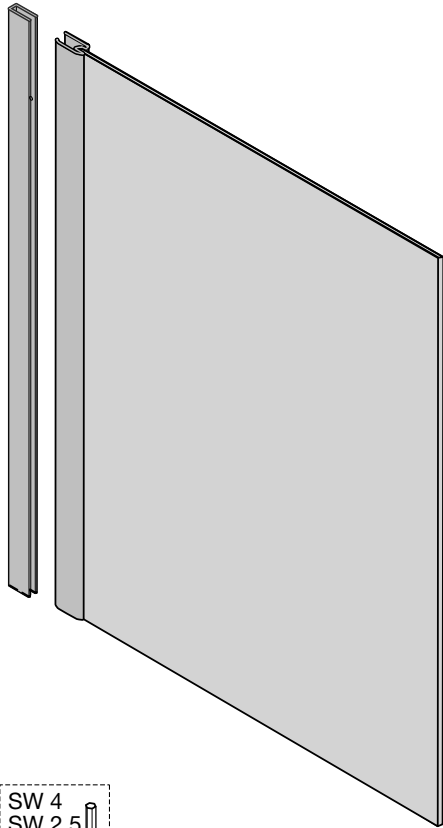
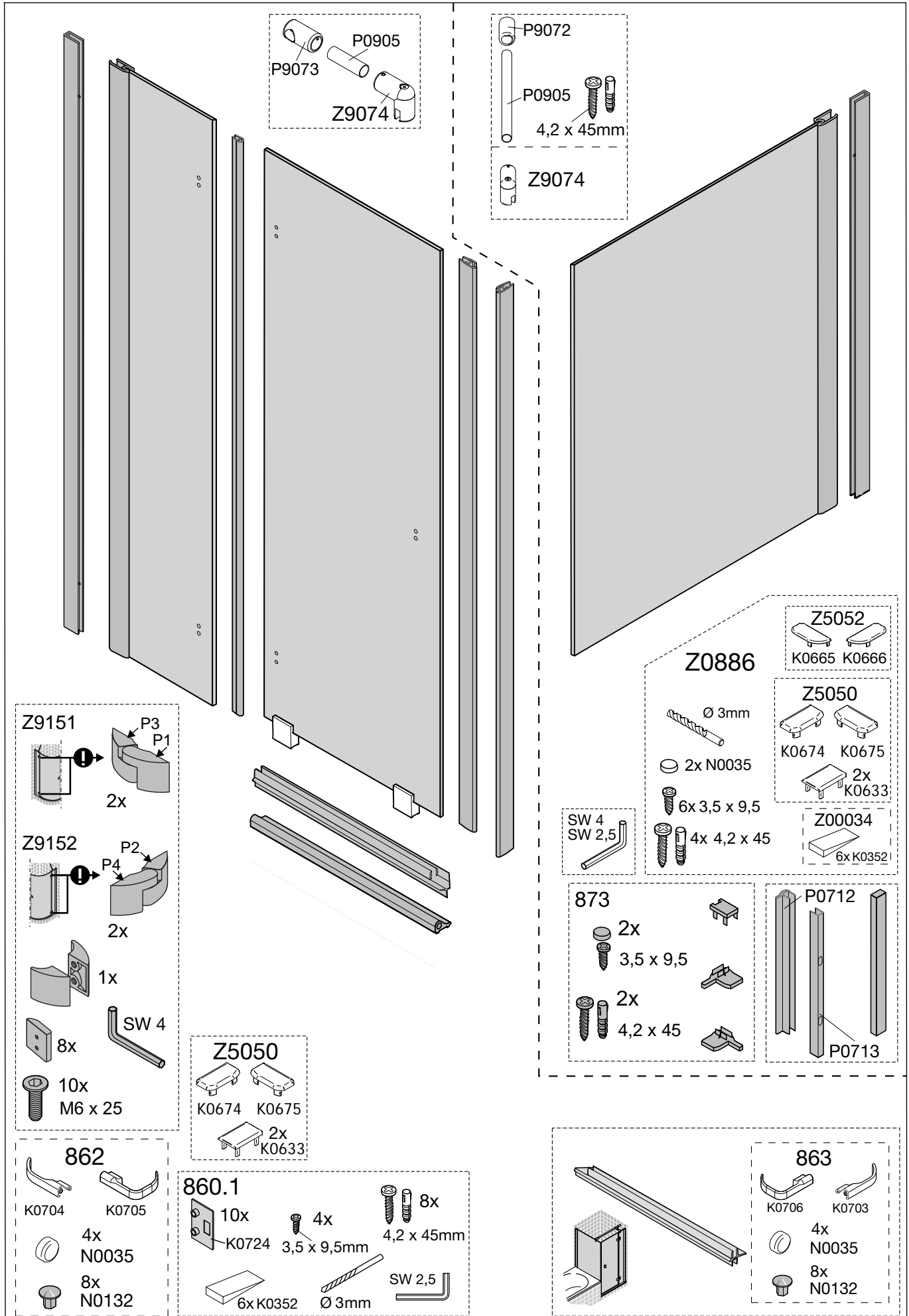

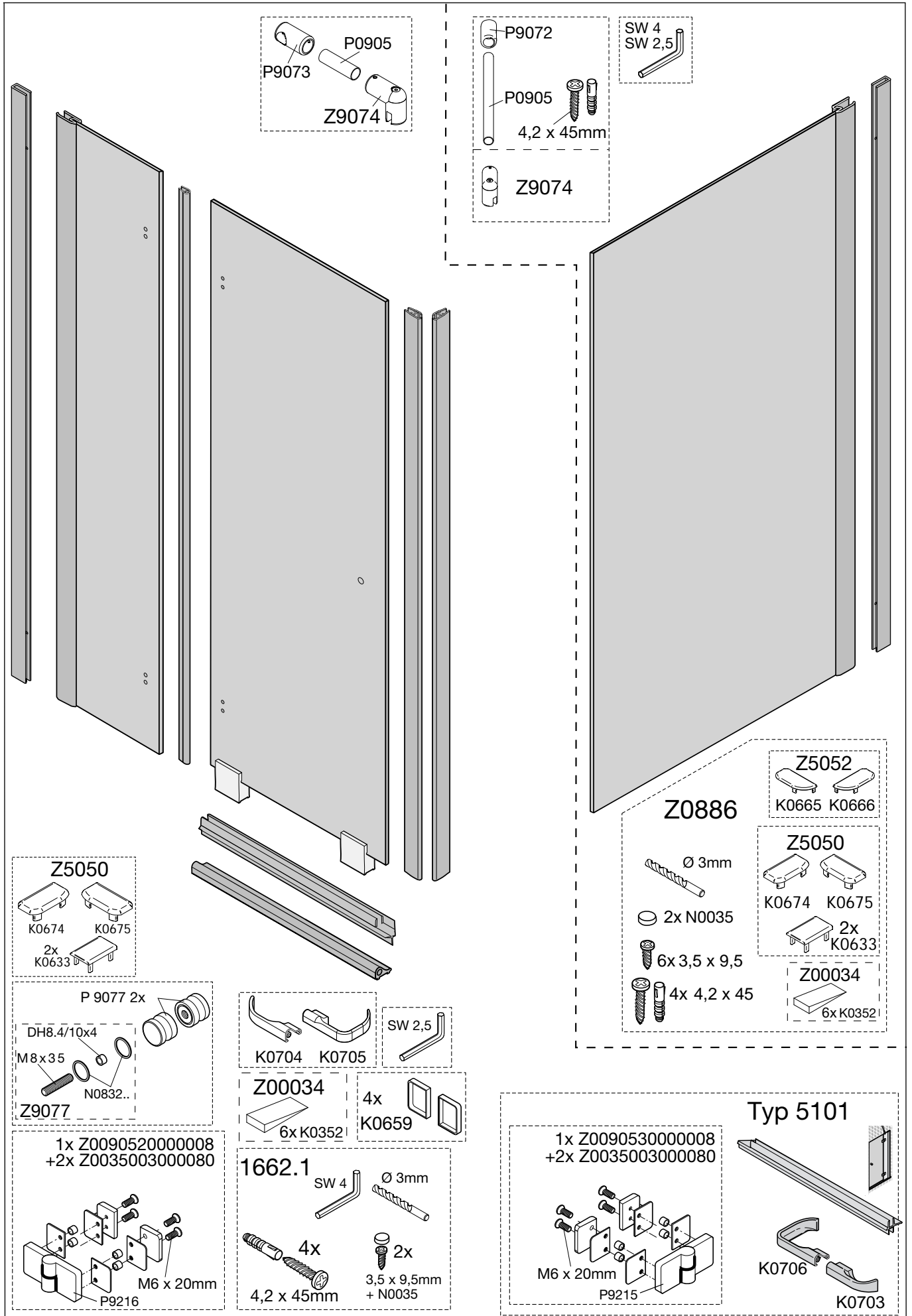

Produktübersicht Typ 0862/0863+0864

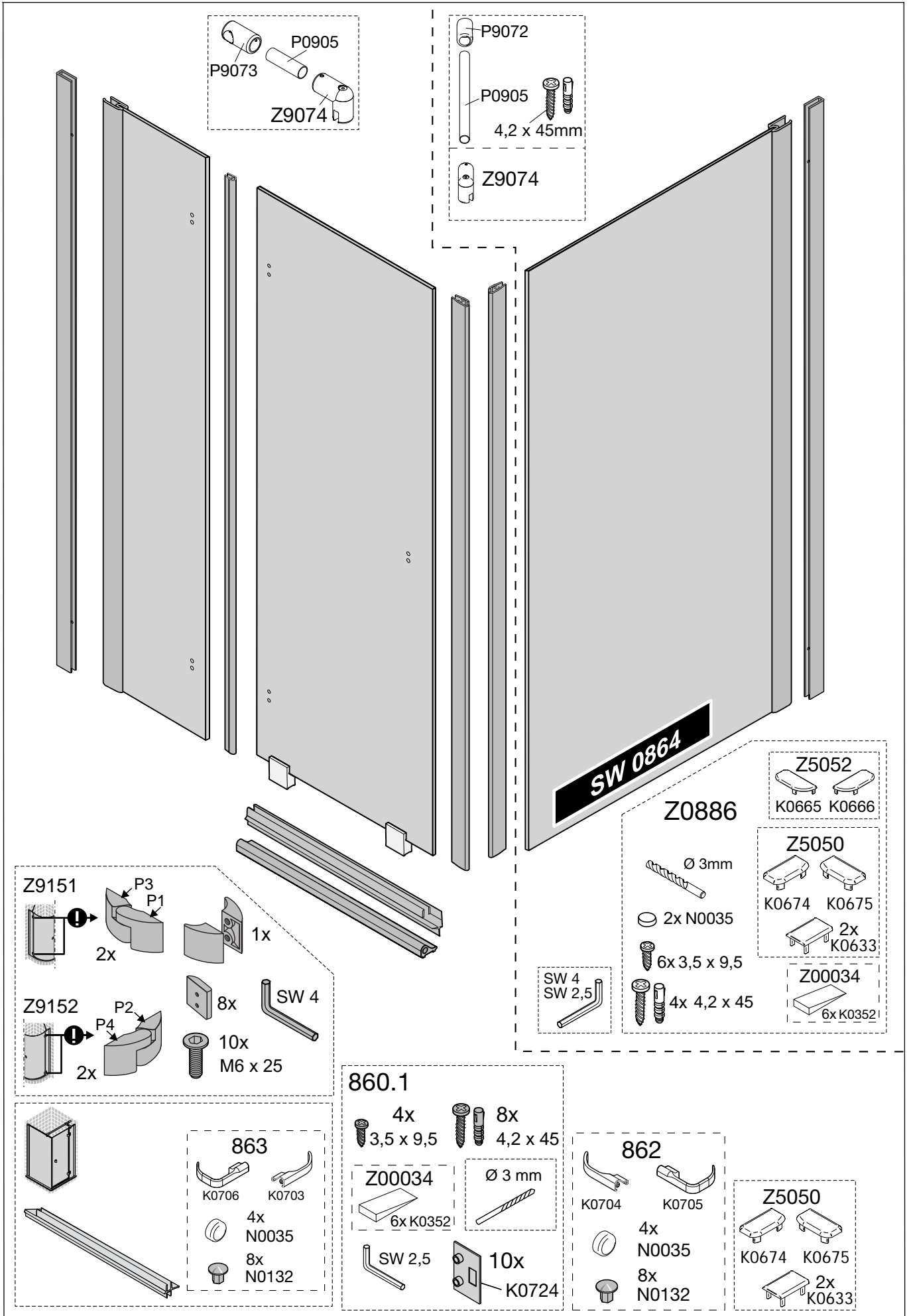

Produktübersicht Typ 0555/0557

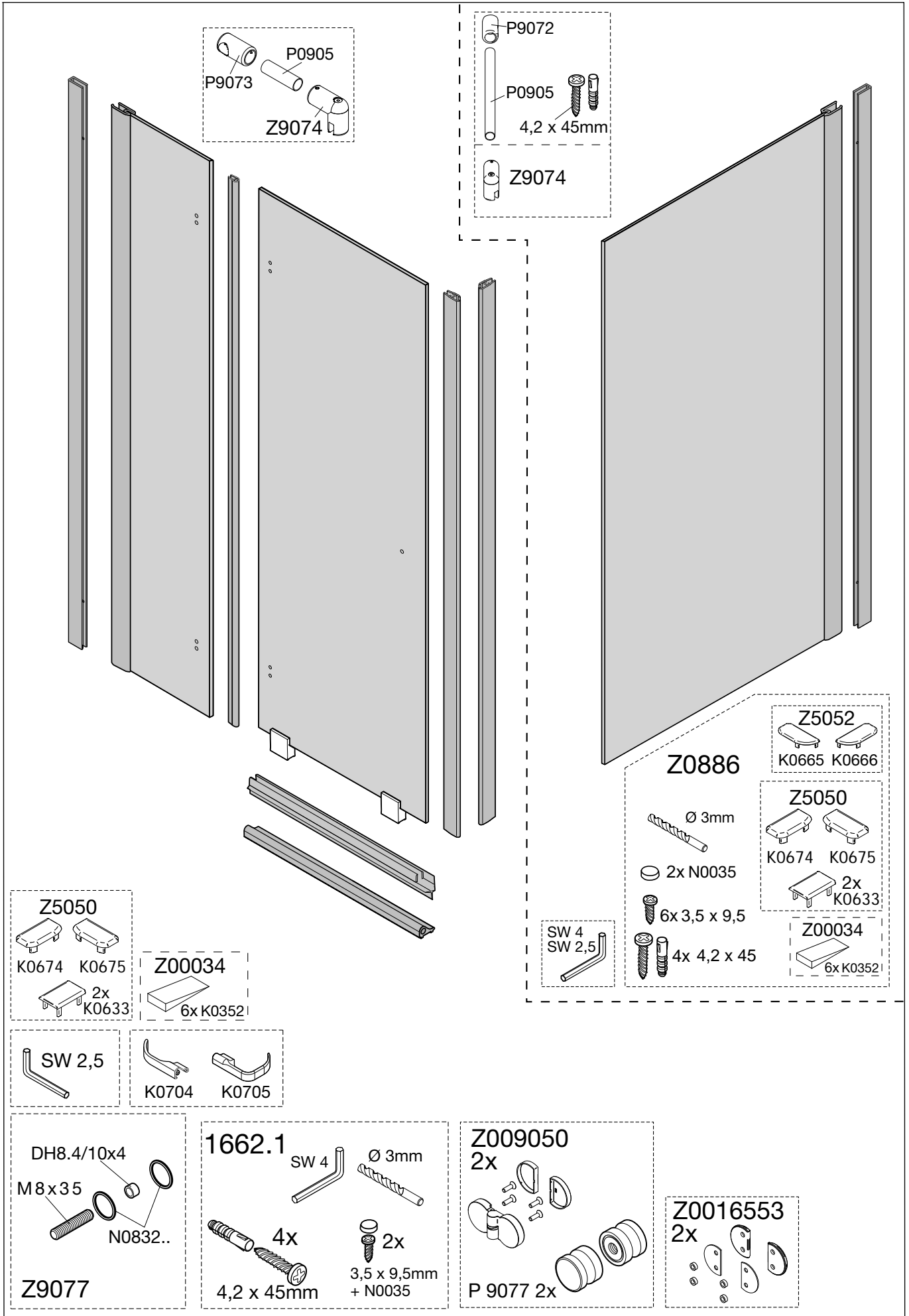

Produktübersicht Typ 0556/0558

