

ZF0044 2x 5 x 3,5 x 9,5 mm	4 x 4,2 x 45 mm	\varnothing 3 mm	ZF0047 8x
----------------------------------	--------------------	--------------------	--------------

ZF5058
2x
K0687

ZF5046
K1518/ K1517

ZE5028

2 x
ZF5086

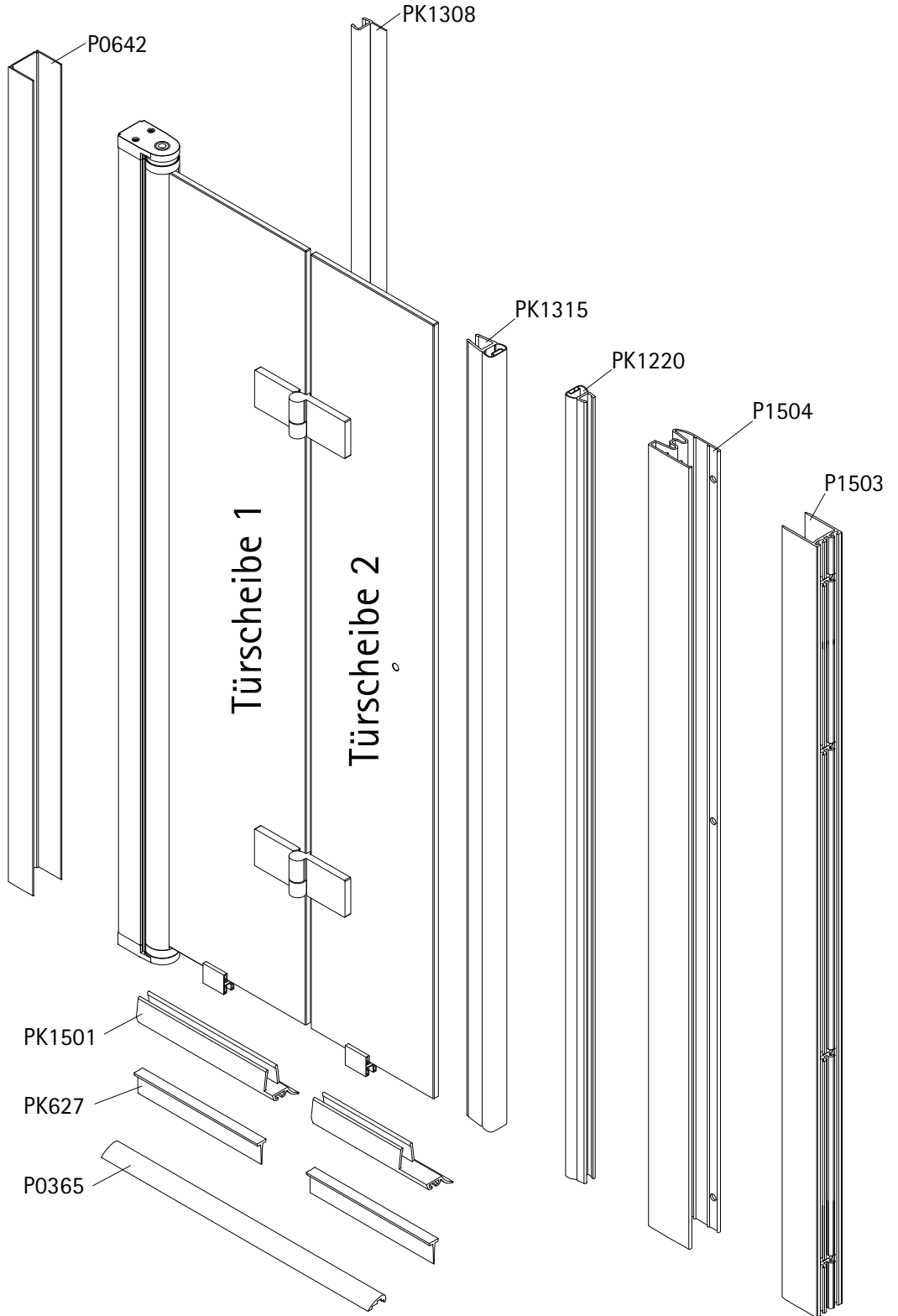

ZF0034
K0352

ZF5039 N0957	K0681	K0682	ZF168 K0386	K0387
-----------------	-------	-------	----------------	-------

ZF0044 2x
 5 x 3,5 x 9,5 mm
 4 x 4,2 x 45 mm
 Ø 3 mm
 ZF0047 8x

ZF5058 2x
 K0687

ZF5046
 K1518/ K1517

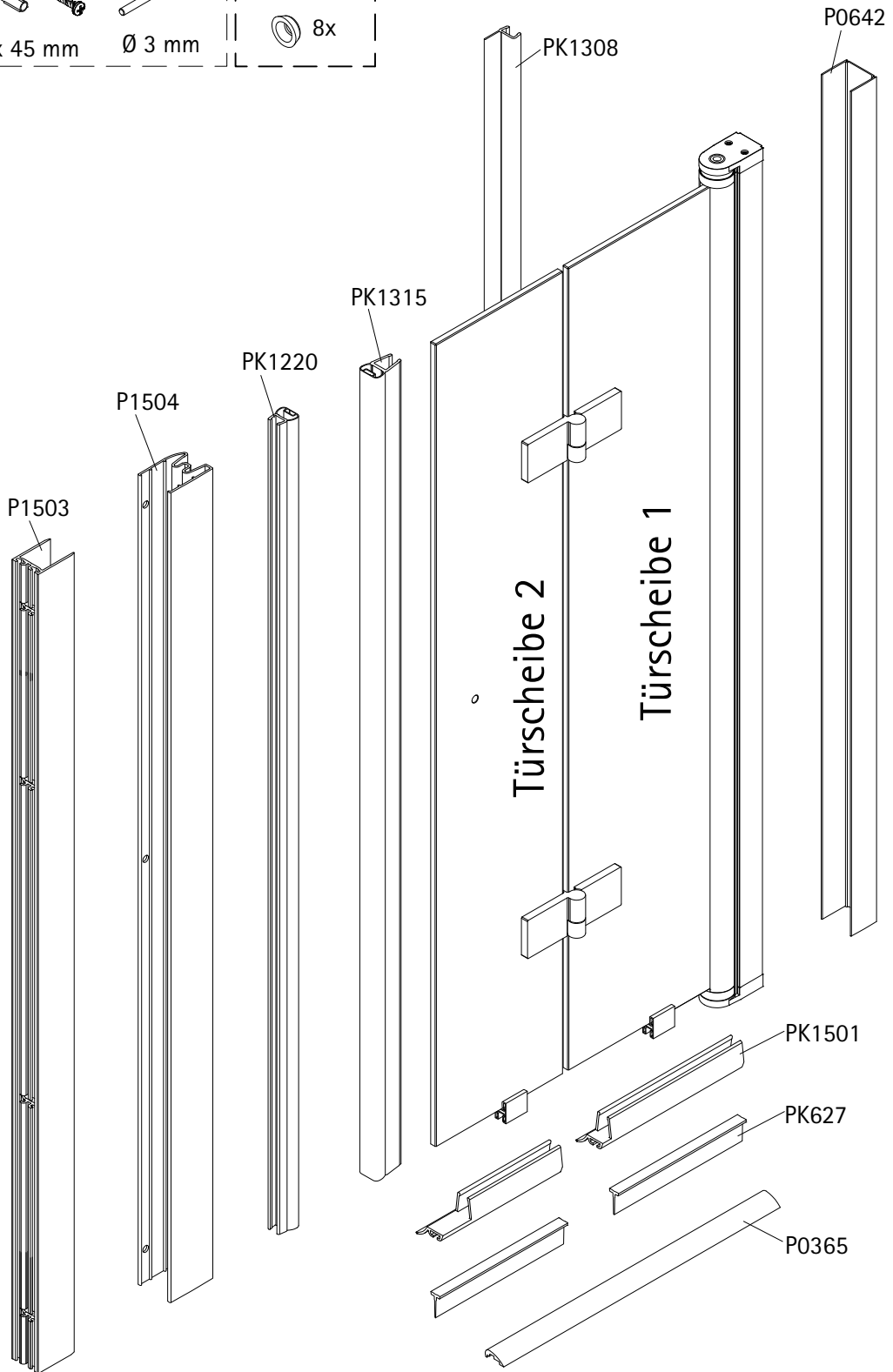

ZE5028

2 x ZF5085



ZF0034
 K0352

ZF5039 N0957
 K0681
 K0682
 ZF168
 K0386
 K0387

ZF0044 2x 5 x 3,5 x 9,5 mm		ZF0047 8x 
	4 x 4,2 x 45 mm	Ø 3 mm

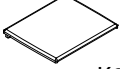
ZF5058
2x
K0687

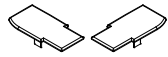

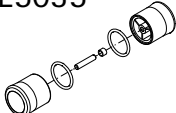

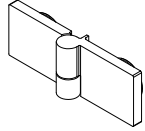
ZF5046
K1518/ K1517

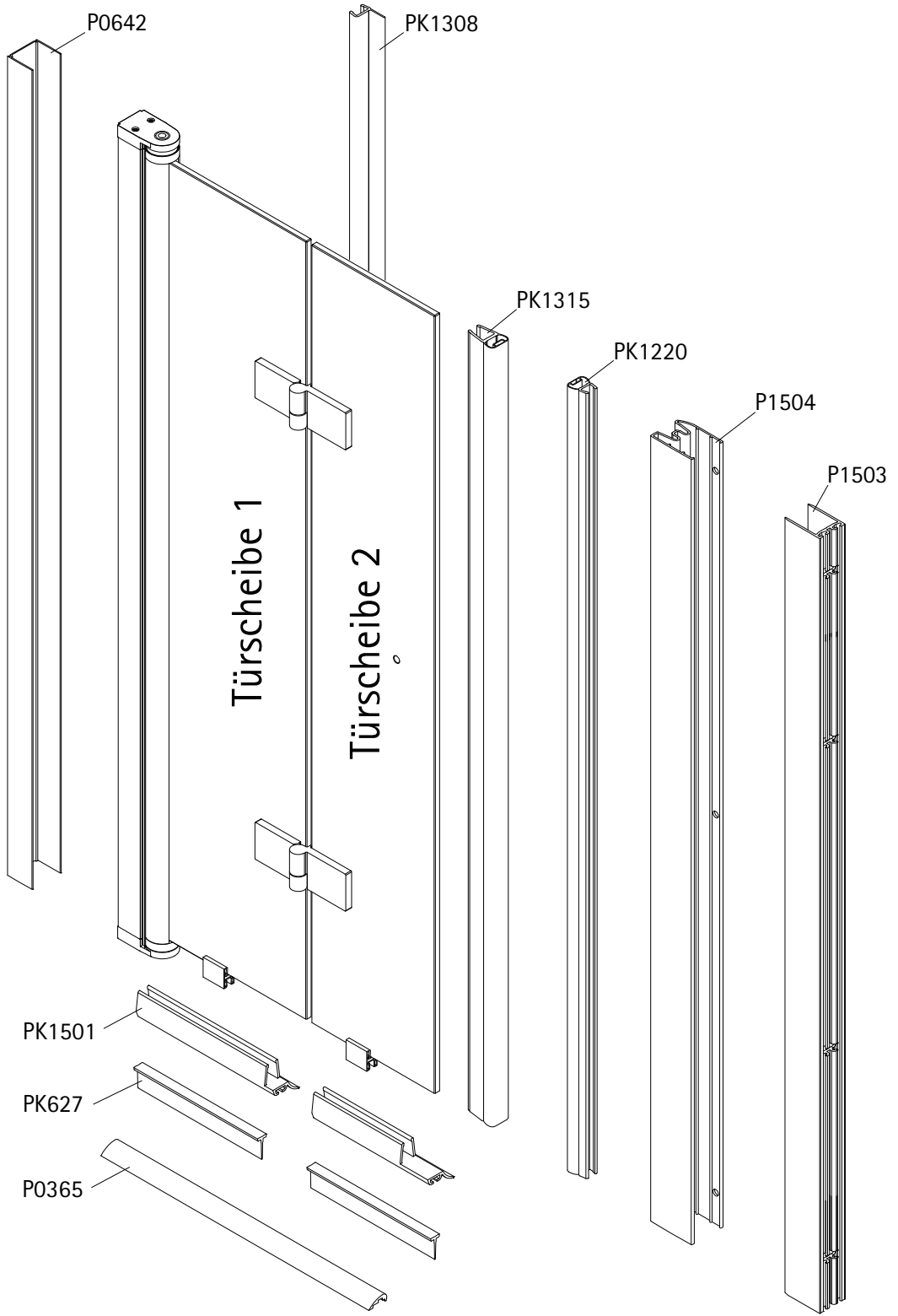

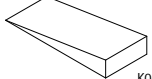

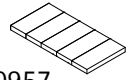
ZE5035

2 x
ZF5086

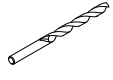

ZF0034
K0352

ZF5039 N0957 	K0681 	K0682 	ZF168 K0386 	K0387 
--	--	--	---	--

ZF0044 2x				ZF0047
5 x		4 x		
3,5 x 9,5 mm		4,2 x 45 mm	Ø 3 mm	8x

ZF5058

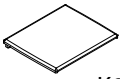
 2x
K0687

ZF5046

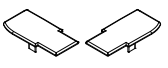
 K1518/ K1517

ZE5035

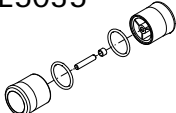



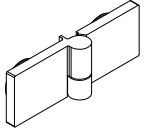

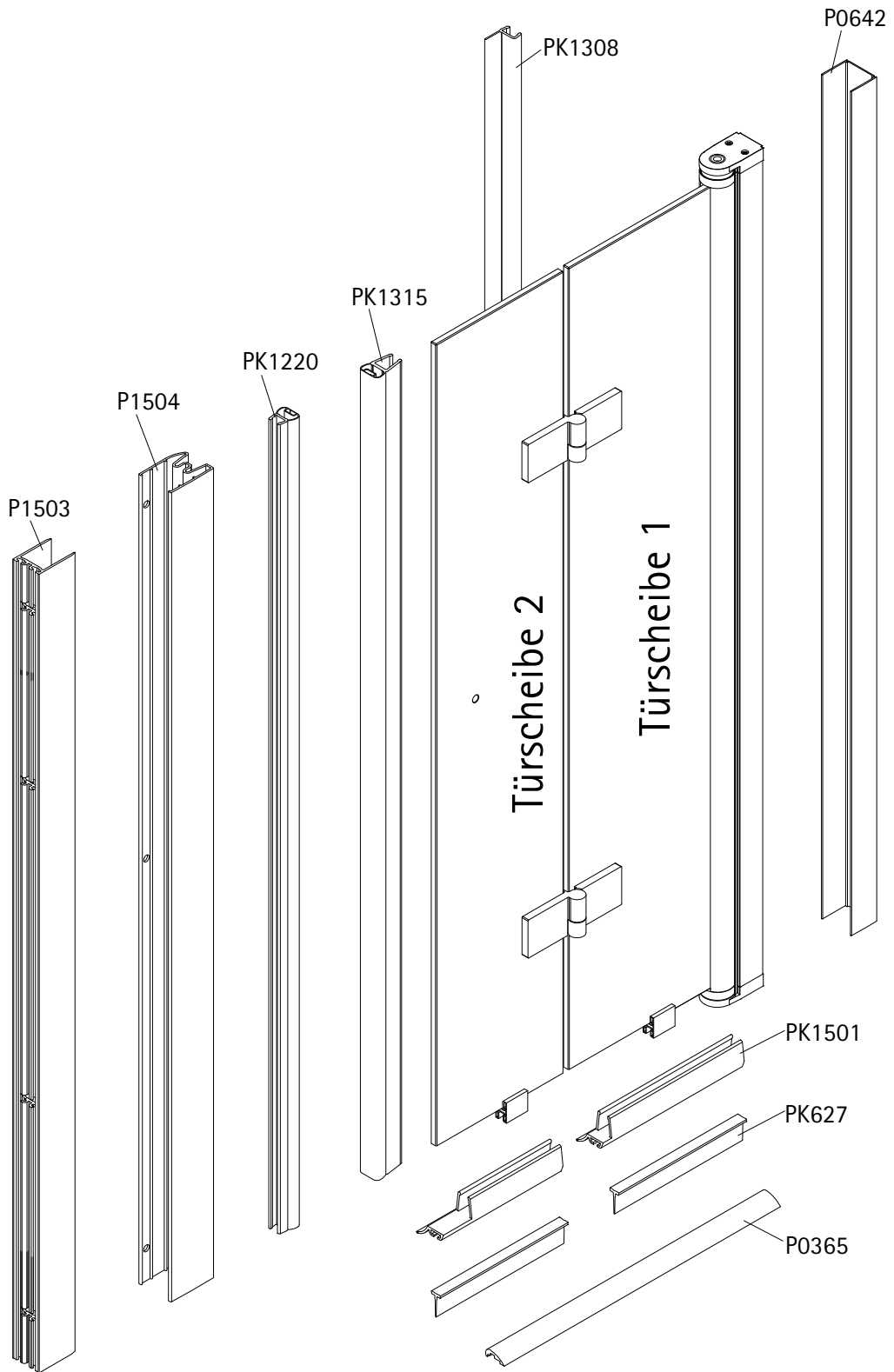
2 x

 ZF5085

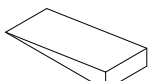

ZF0034

 K0352

ZF5039			ZF168	
N0957	K0681	K0682	K0386	K0387